

1.

**Börse
und
Shareholders**

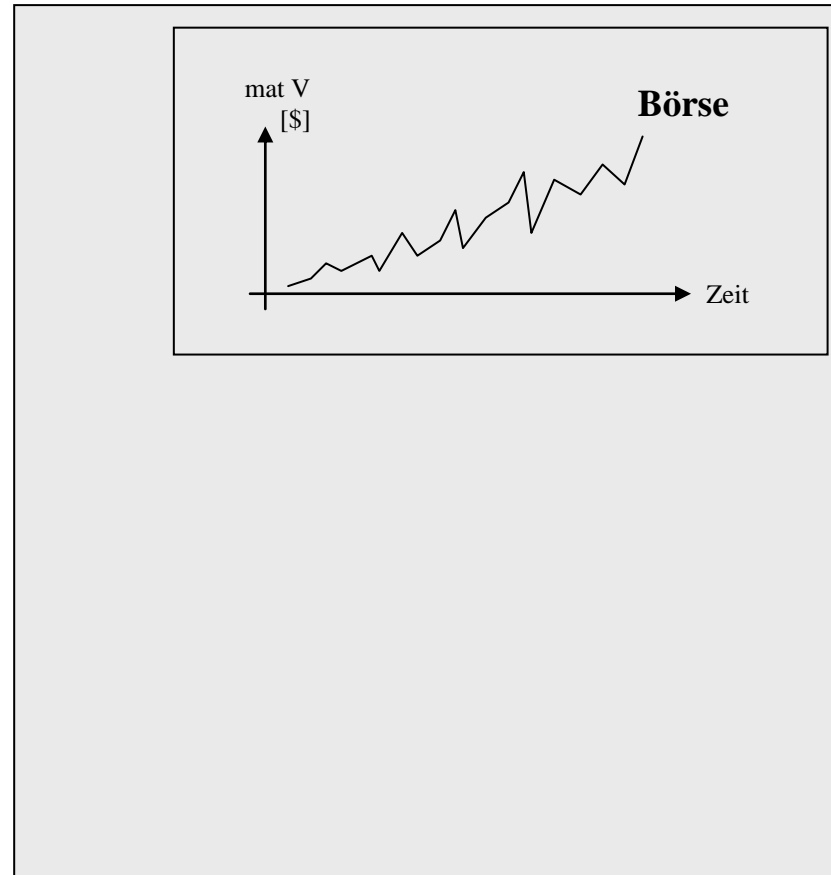

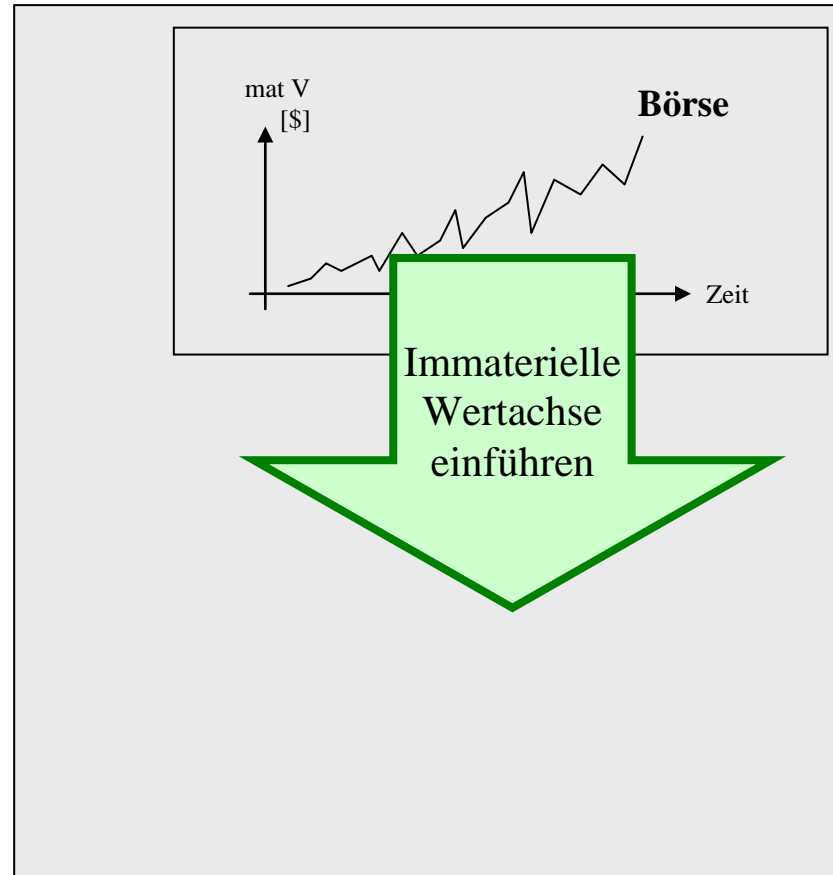

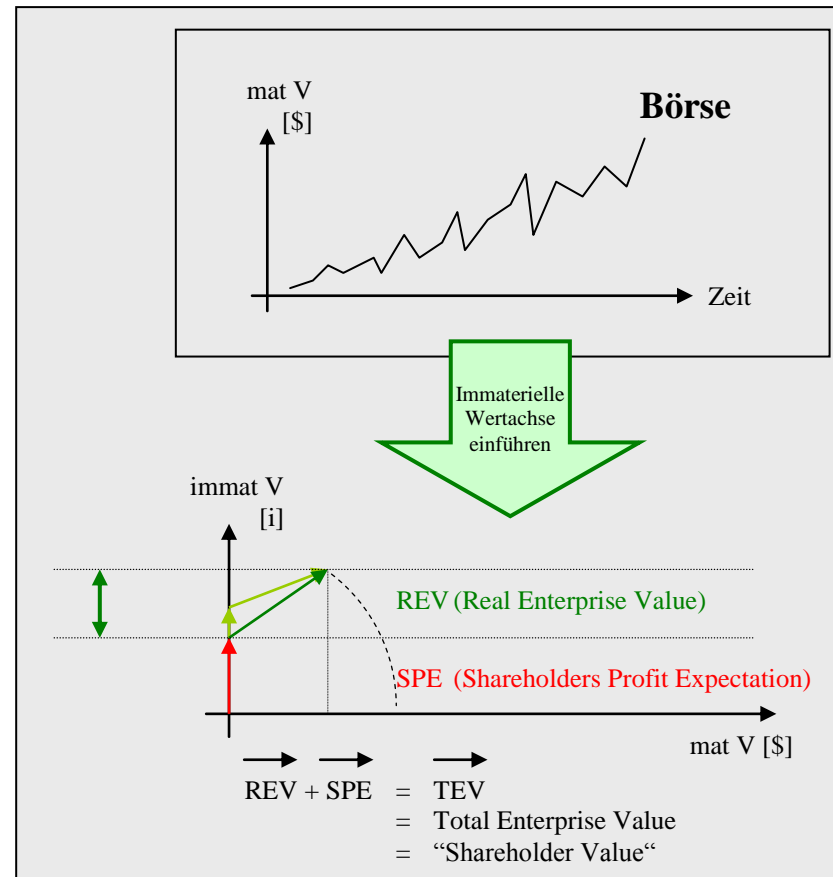

2.

Enterprise (Form und Inhalt)

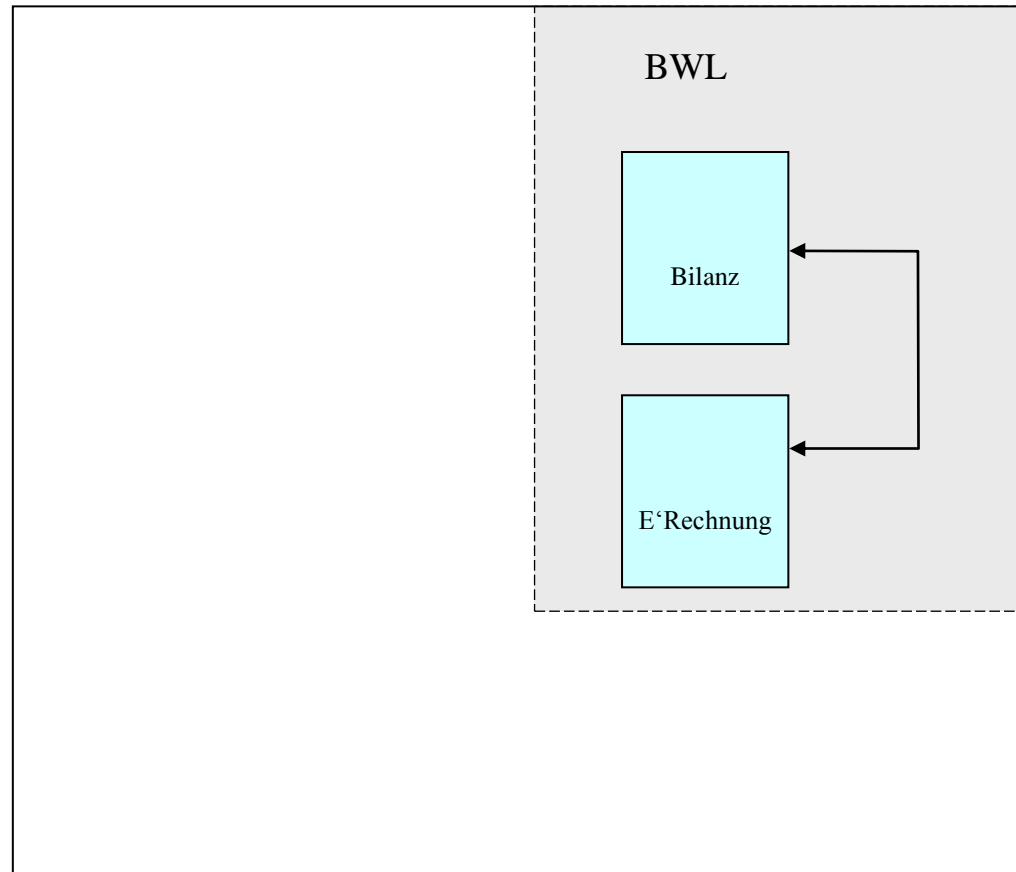

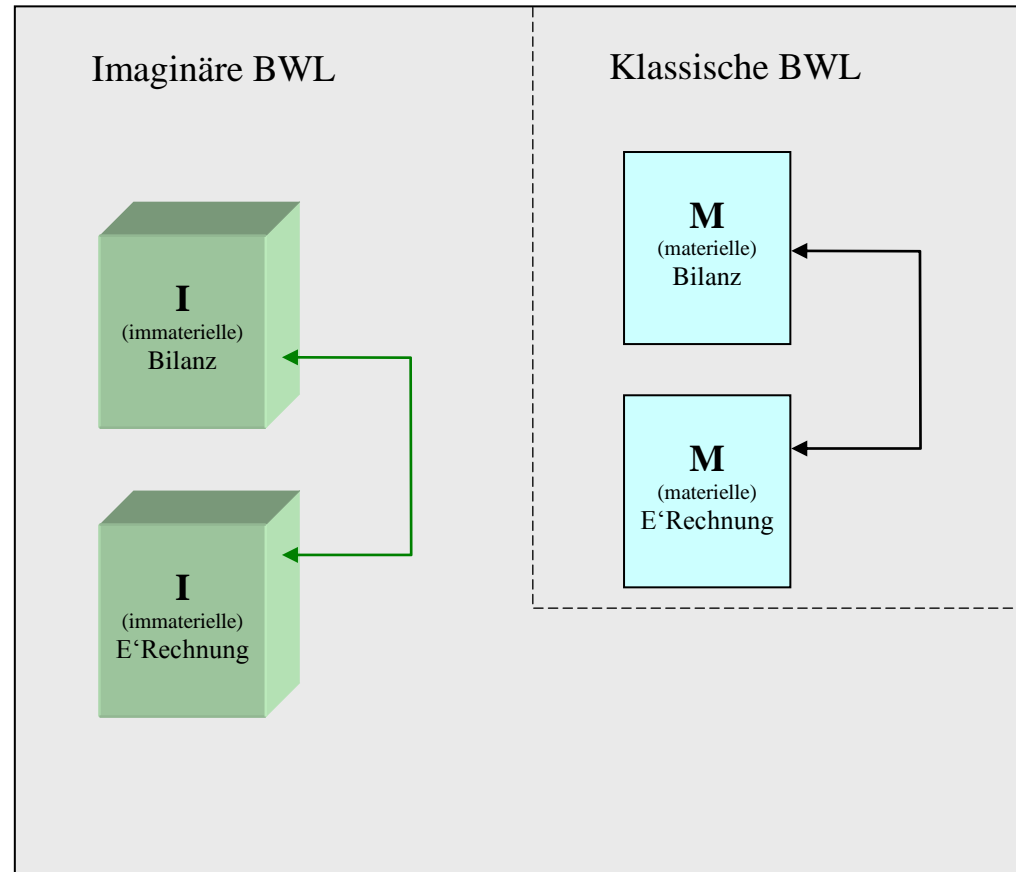

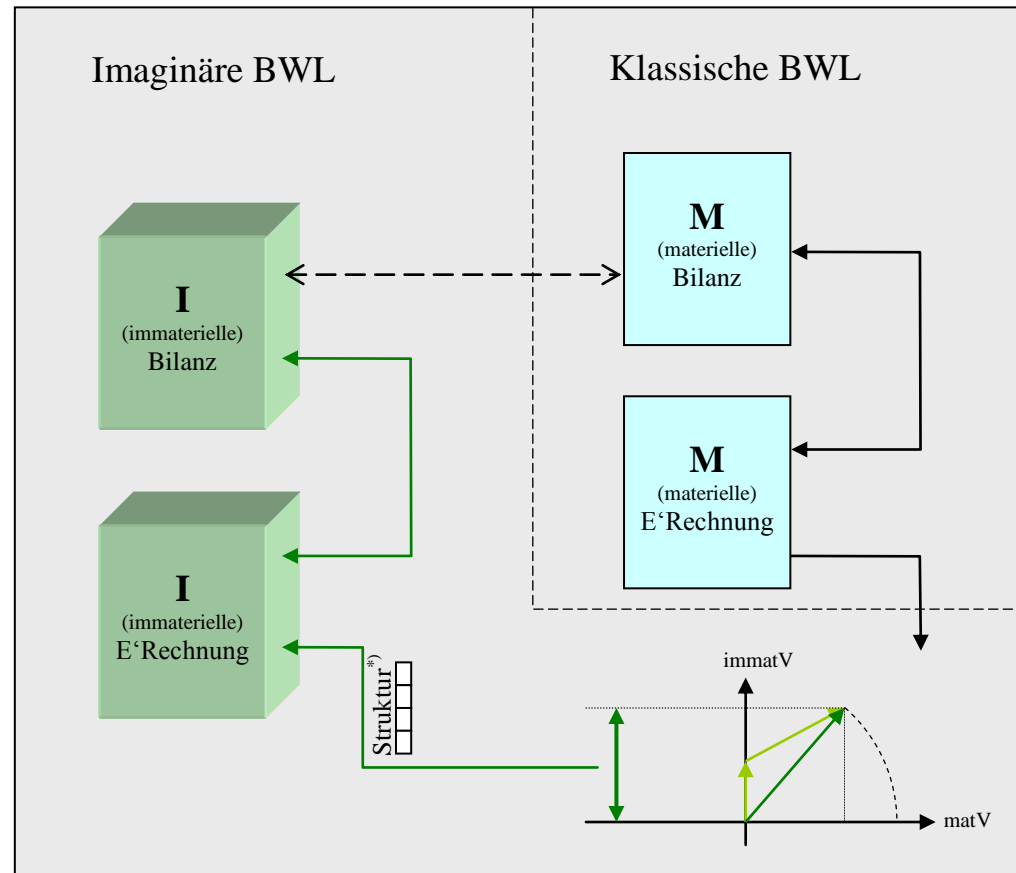

*) Beispielsweise:
 BSC, EVA, BIG, UPR, B'E . . .
 nach individuellen Erfordernissen

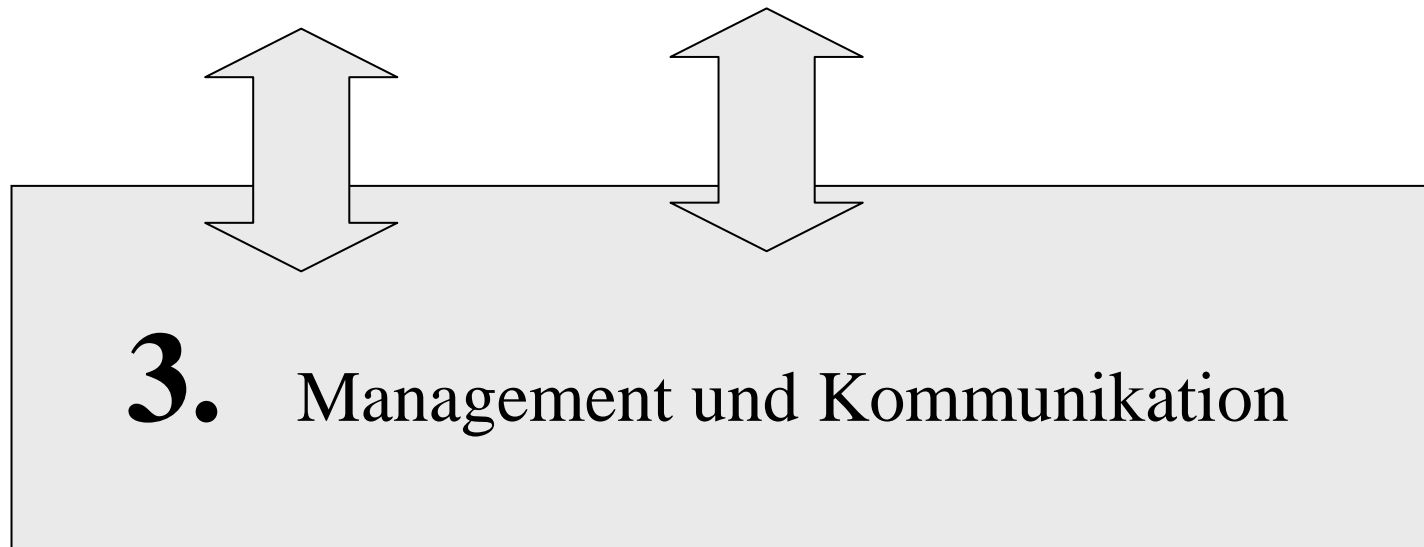

Unternehmen

Kapitalgeber

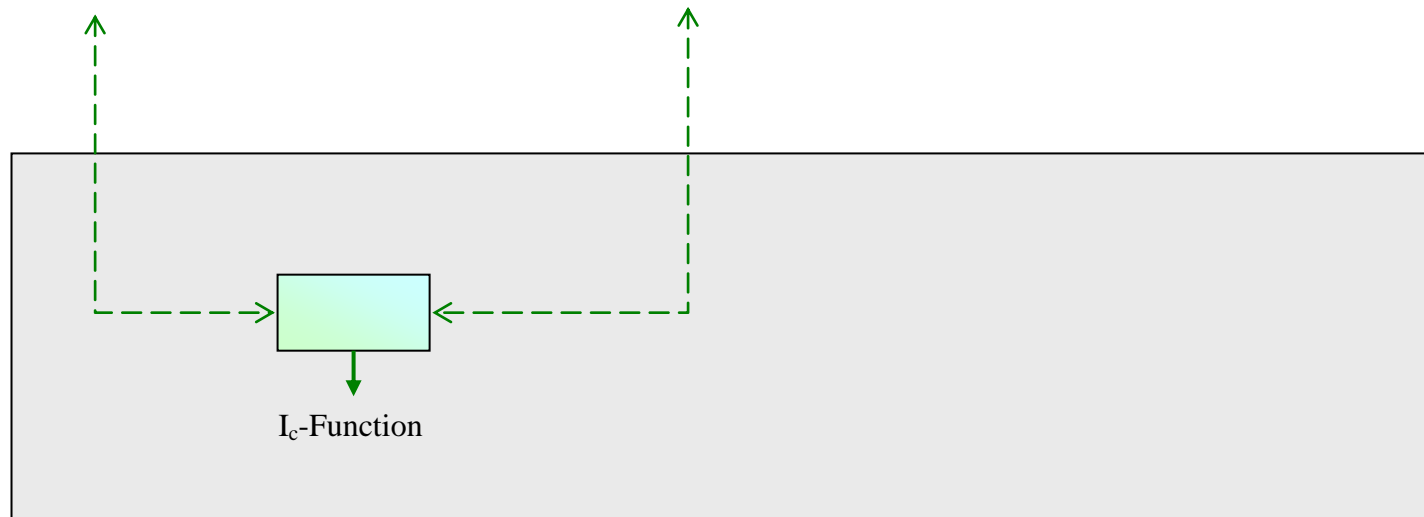

Unternehmen

Kapitalgeber

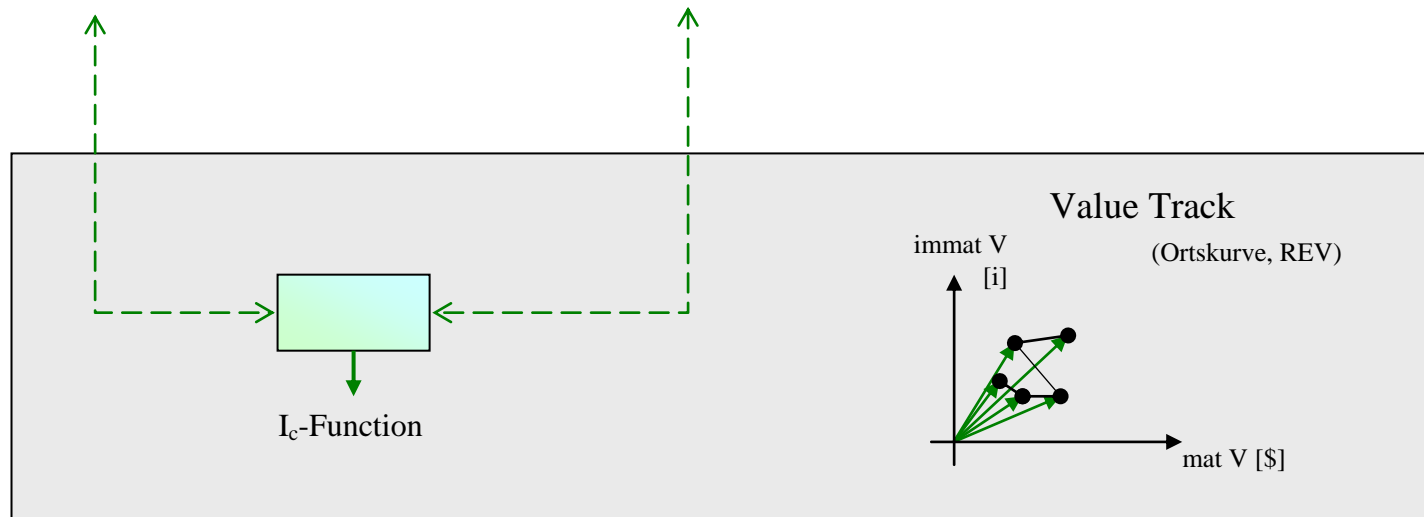

Economic Value Architecture & Engineering

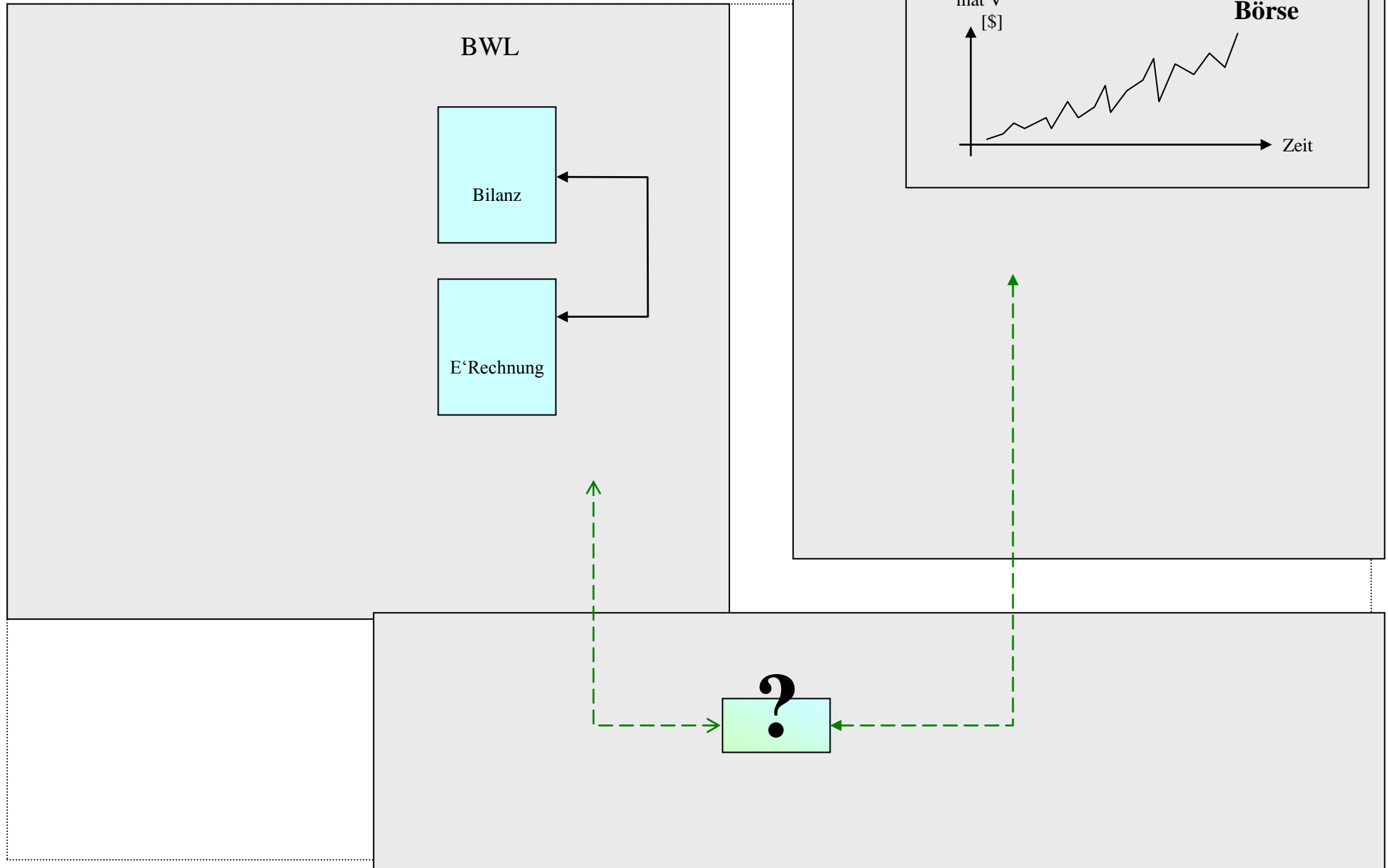

Economic Value Architecture & Engineering

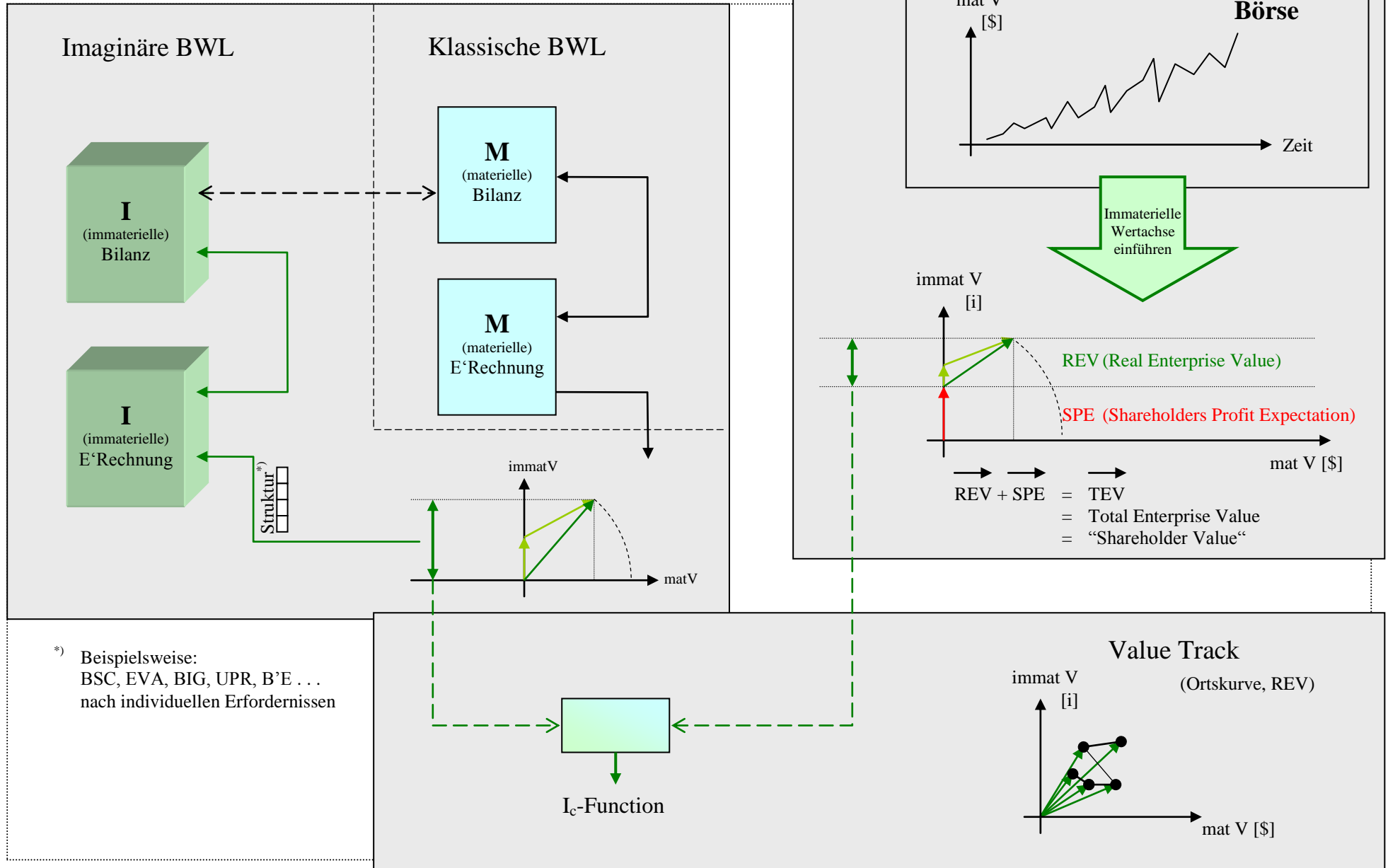

*) Beispielsweise:
BSC, EVA, BIG, UPR, B'E . . .
nach individuellen Erfordernissen